

SCALE: 1/4

## LOCK STILE OPTIONS

For Selection Purposes Only.  
Samples shown non-thermally broken  
extrusions

### ARCHETYPE

### ARCHETYPE NARROW

STANDARD

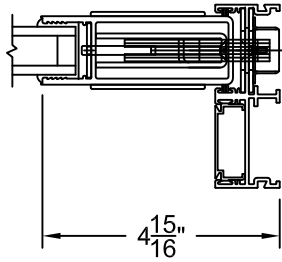

1" SIGHTLINE EXTENDER

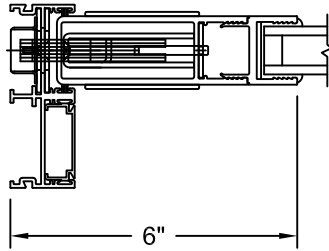

STANDARD

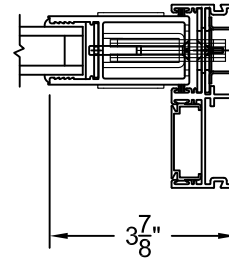

1" SIGHTLINE EXTENDER

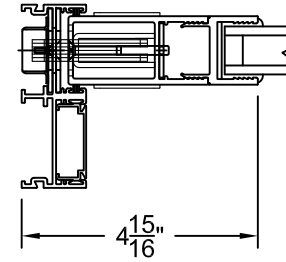

HP2 ADAPTER

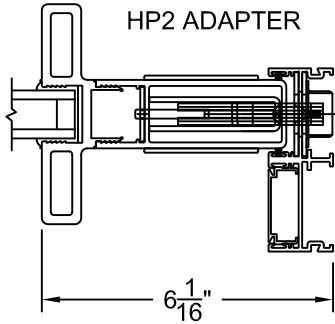

2.5" SIGHTLINE EXTENDER

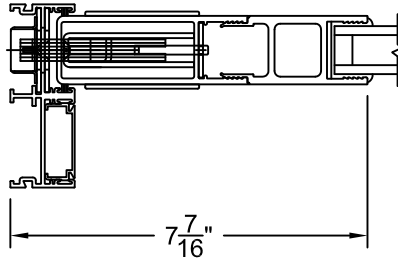

HP2 ADAPTER

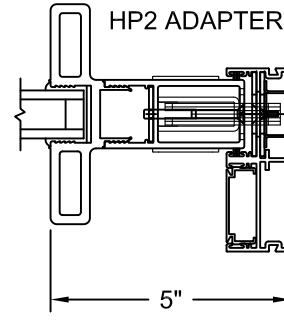

2.5" SIGHTLINE EXTENDER

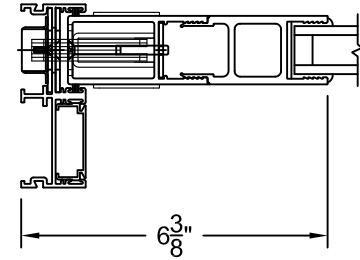

HP1 ADAPTER

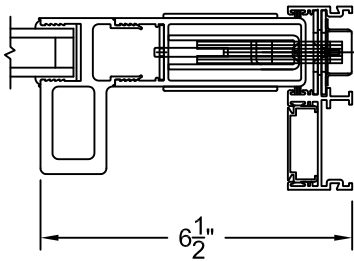

3.5" SIGHTLINE EXTENDER

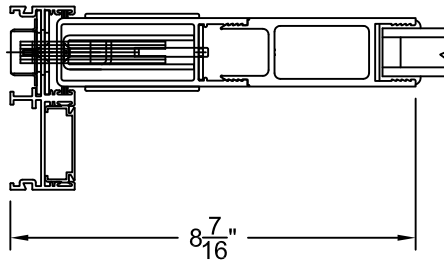

HP1 ADAPTER

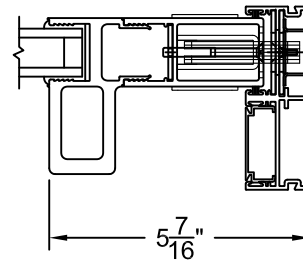

3.5" SIGHTLINE EXTENDER

