

(USE RULER TO SCALE DIMENSIONS IN INCHES)

SCALE: 1/4

MULTI-SLIDE DOOR DETAILS WITH SCREENS

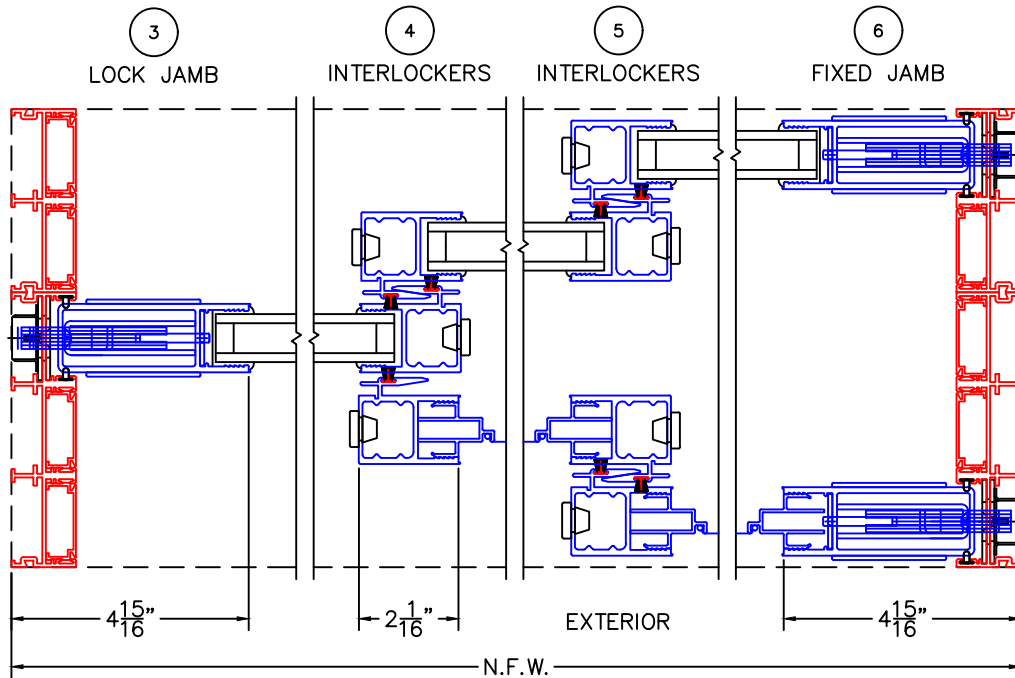
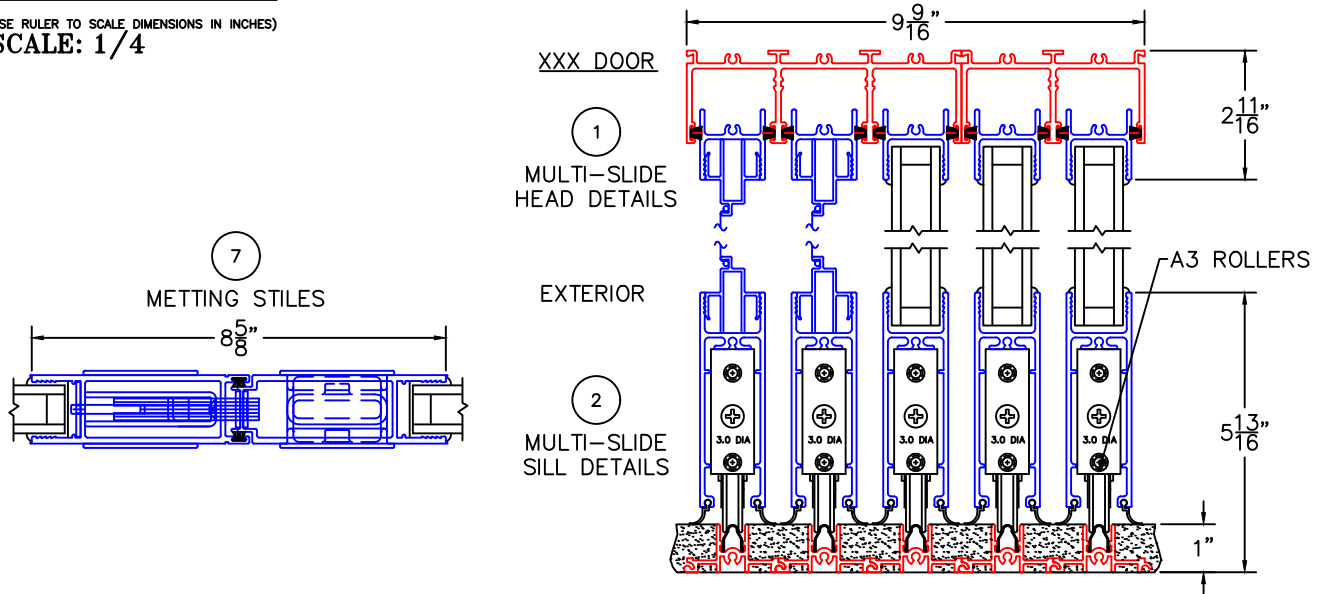

NOTE: CENTERLINES ARE NOT DIVIDED EQUALLY; CONFIRM CENTERLINES WHEN REQUIRED

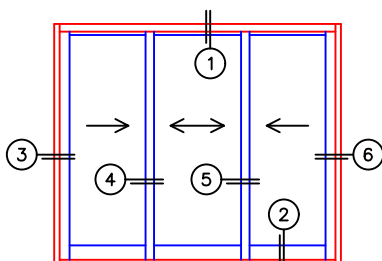

XXX DOOR

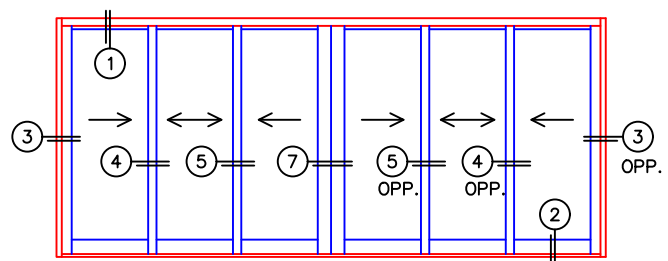

XXXIXXX DOOR

-GLASS PENETRATION: 11/16"  
-FOR ADDITIONAL OPTIONS AND UPGRADES  
SEE DRAWINGS 3050-08, 3050-09 & 3050-10.

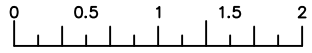

(USE RULER TO SCALE DIMENSIONS IN INCHES)

SCALE: 3/4

XXX DOOR

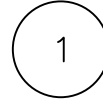

MULTI-SLIDE  
HEAD DETAILS

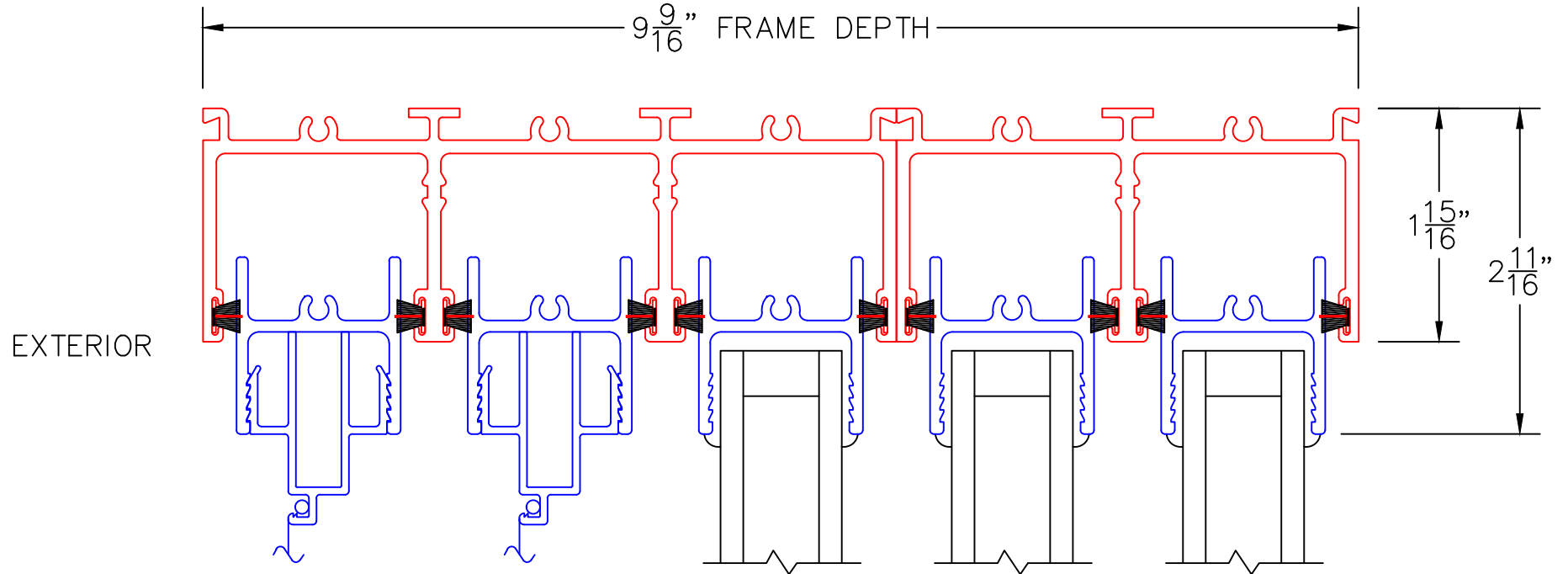

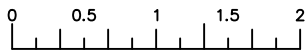

(USE RULER TO SCALE DIMENSIONS IN INCHES)

SCALE: 3/4

XXX DOOR

EXTERIOR

2

MULTI-SLIDE  
SILL DETAILS

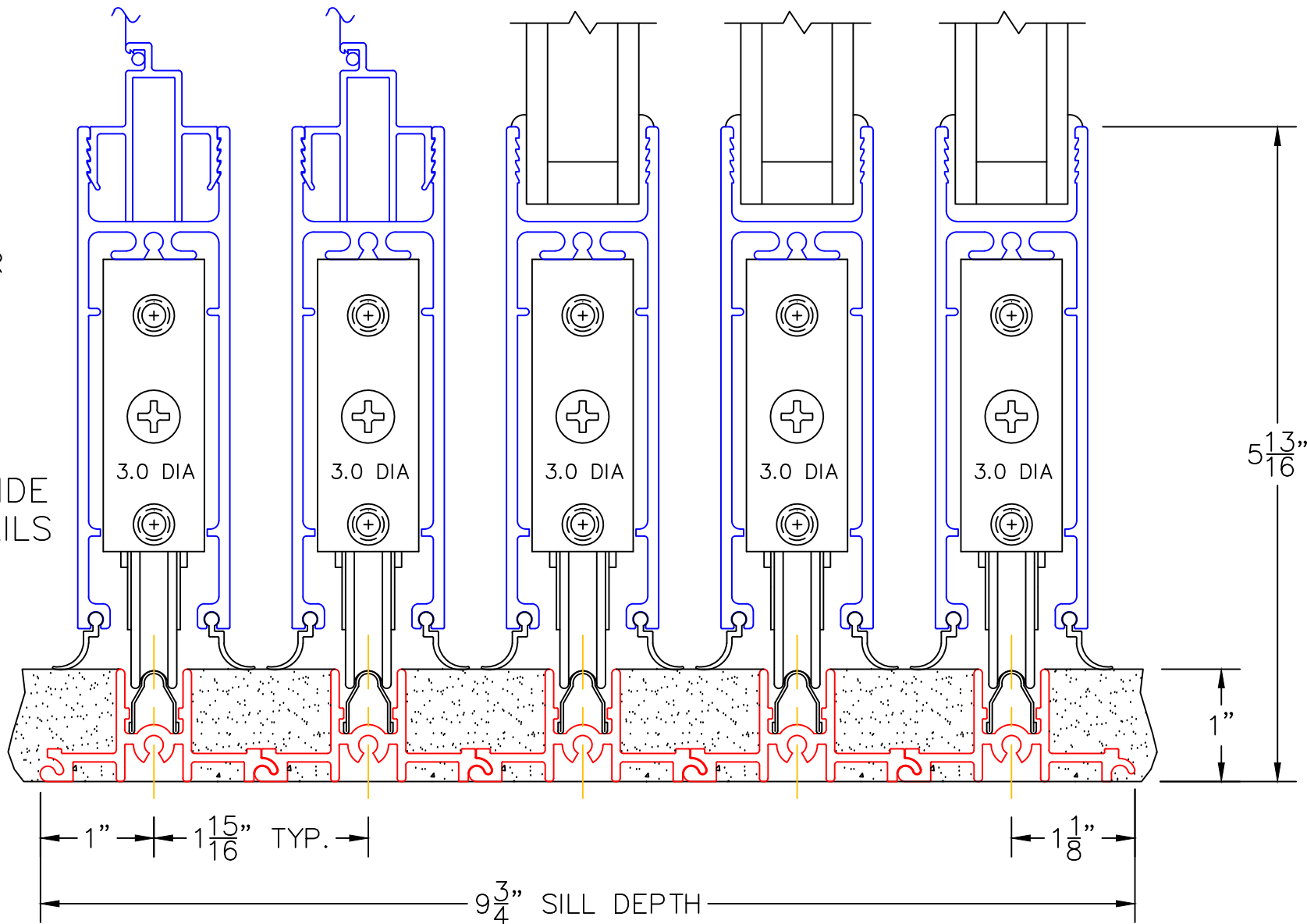

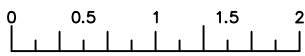

(USE RULER TO SCALE DIMENSIONS IN INCHES)

SCALE: 3/4

XXX DOOR  
HIDDEN TRACK

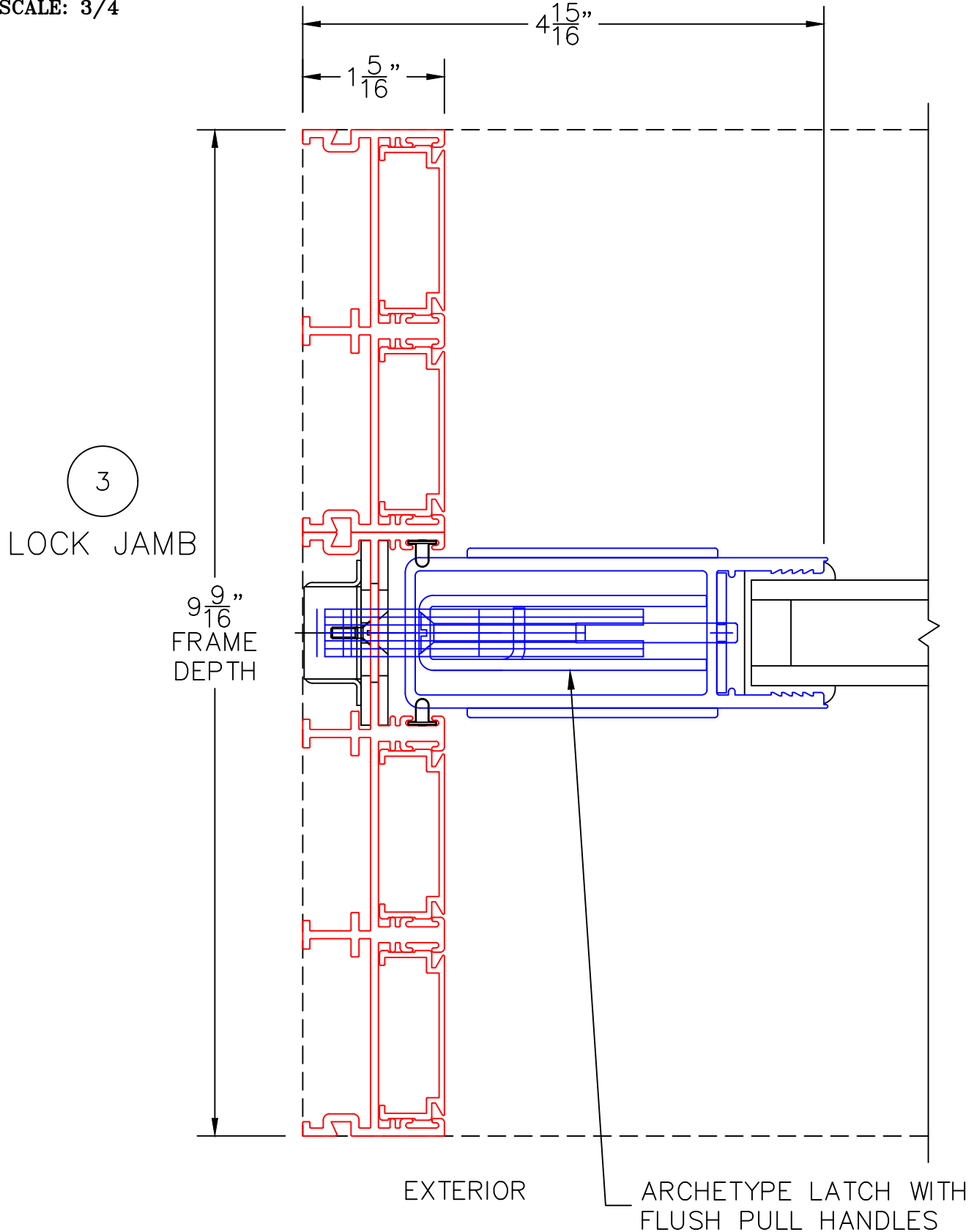

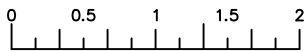

(USE RULER TO SCALE DIMENSIONS IN INCHES)

SCALE: 3/4

## XXX DOOR HIDDEN TRACK

4  
INTERLOCKERS

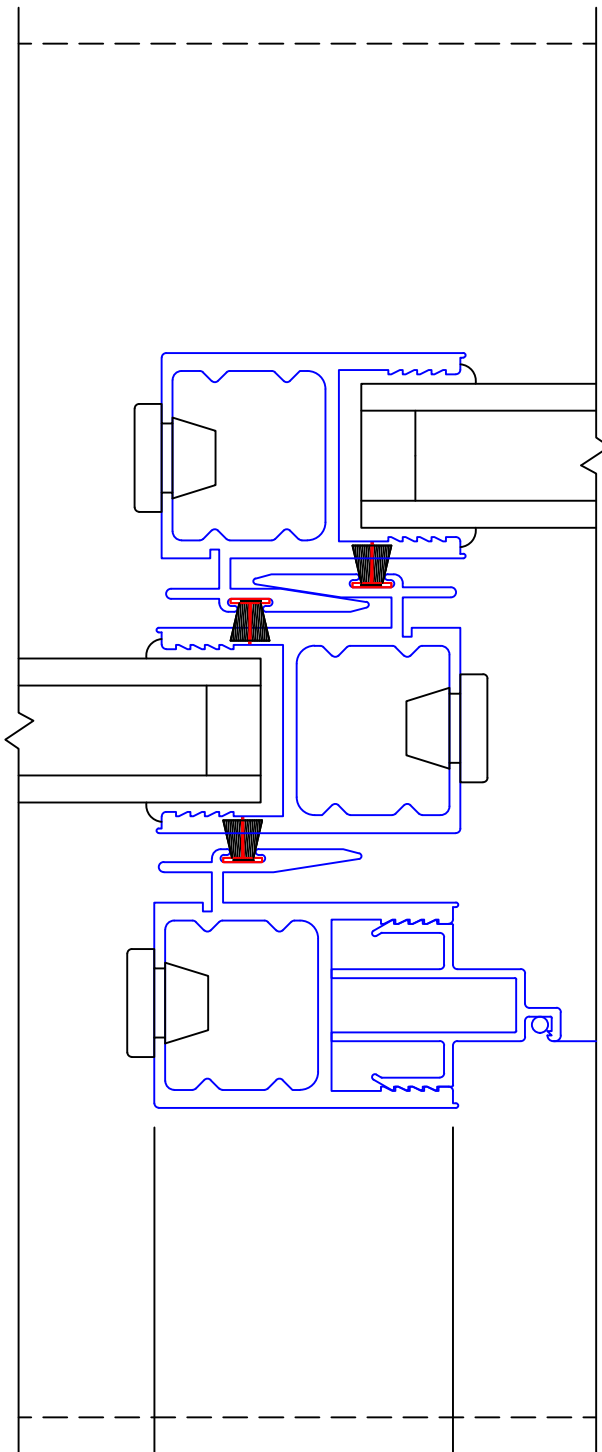

2 <sup>1</sup>/<sub>16</sub> "

EXTERIOR

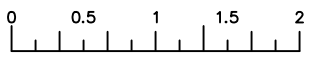

(USE RULER TO SCALE DIMENSIONS IN INCHES)

SCALE: 3/4

XXX DOOR  
HIDDEN TRACK

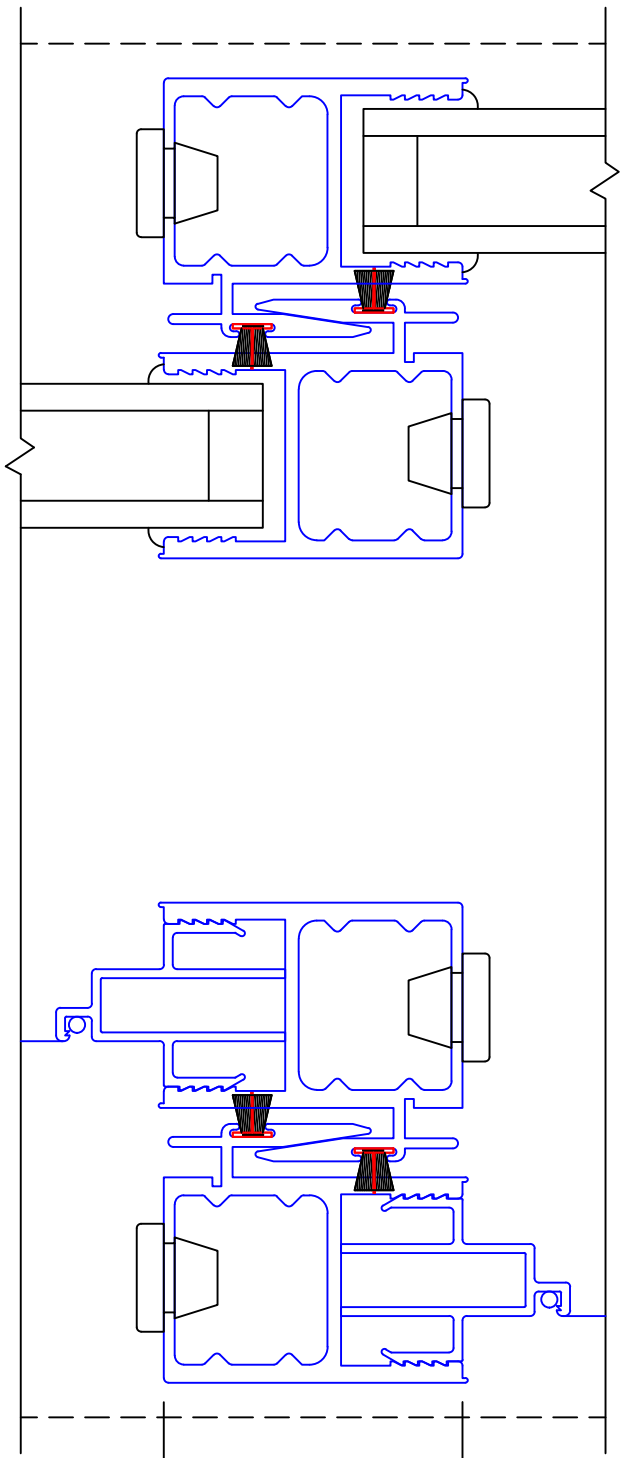

5

INTERLOCKERS

2 1/16"

EXTERIOR

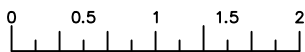

(USE RULER TO SCALE DIMENSIONS IN INCHES)

SCALE: 3/4

XXX DOOR  
HIDDEN TRACK

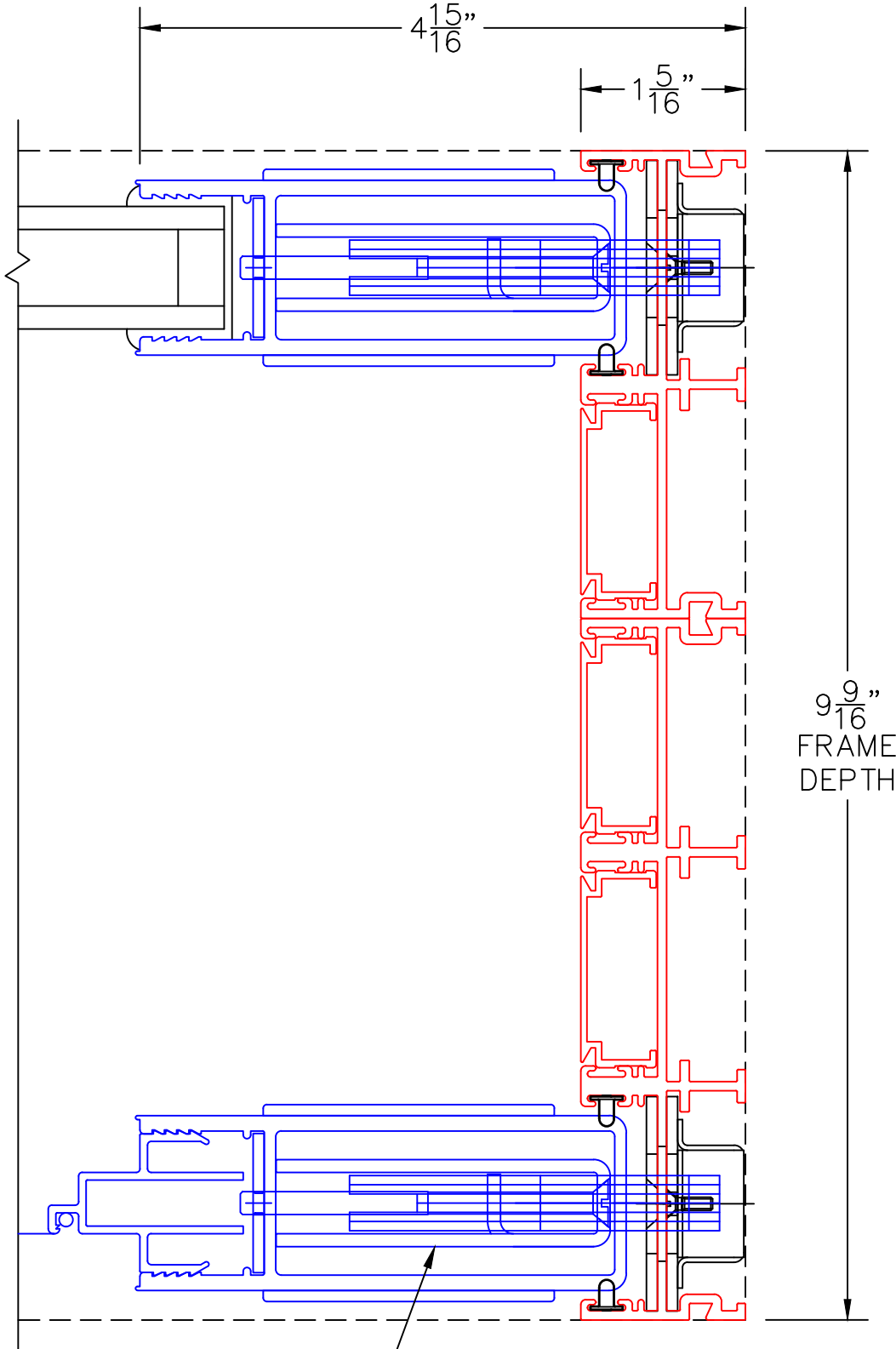

6

LOCK JAMB

9 9/16"  
FRAME  
DEPTH

ARCHETYPE LATCH WITH  
FLUSH PULL HANDLES

EXTERIOR

0 0.5 1  
(USE RULER TO SCALE DIMENSIONS IN INCHES)  
**SCALE: FULL**

XXXIXX DOOR  
HIDDEN TRACK

7

MEETING STILES

85"  
8

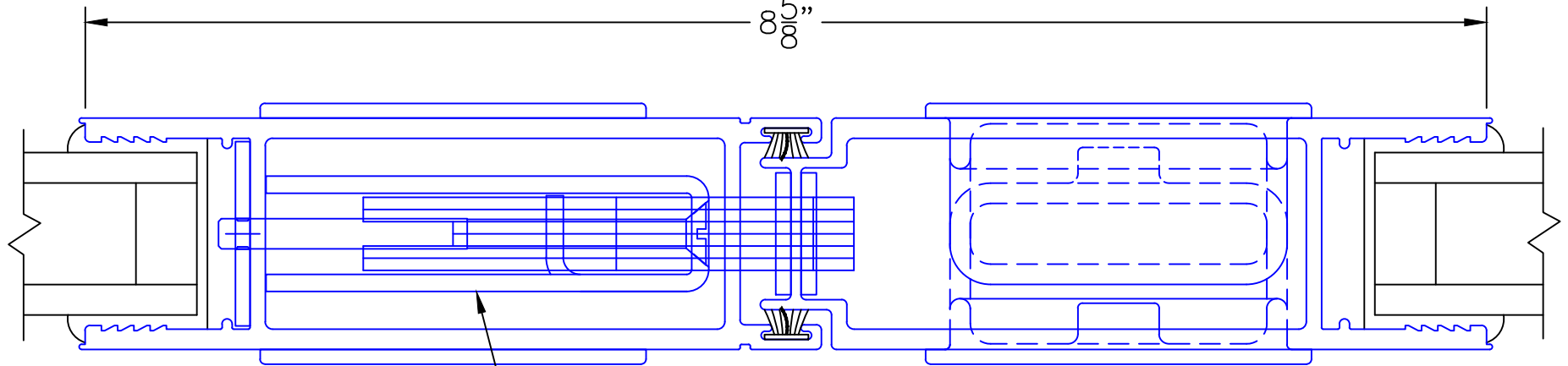

ARCHETYPE LATCH WITH  
FLUSH PULL HANDLES

EXTERIOR